

KTM JACKETED BALL VALVES

FULL BORE AND REDUCED BORE

KTM jacketed ball valve, designed with full flange to flange welded jacket, to effectively maintain the temperature of the media



FEATURES

- Enhanced design with proven OM-II internal design features for maximum safety, sealing integrity and reliability
- Full jacketed design effectively maintains the temperature of the media
- High-pressure resistant jacket for supply of steam or cooling media up to 1.0 MPa (145 psi)
- Reinforced PTFE bearing and packing rings for superior performance
- Split construction of cap and seat holder simplifies maintenance
- Compact and light-weight design
- Machined ISO 5211 top mounting flange
- Positive position indicator
- Blow-out proof shaft (DN 100/ NPS 4 and larger)
- Shaft seals positioned low on the shaft to avoid fluid from sticking, minimizing excessive torque and shaft torsion
- In addition to standard E-seat, various seats are available. Each seat option will allow a wide range of performance, suitable for many applications
 - PTFE / PFA copolymer: E-seat (standard)
 - PEEK seat (option)
 - Grati[®] seat (option)
 - Metallite[®] seat (option)

GENERAL APPLICATIONS

Temperature-dependent viscosity fluid: heavy oil, asphalt, coal tar

Option

- Jacket nozzle flanges

TECHNICAL DATA

Models/sizes: Full bore JB11/JB12
 DN 15 to DN 200 (NPS ½-8)
 Reduced bore JB21/JB22
 DN 80 to DN 250 (NPS 3-10)

Pressure rating: JIS 10K, 20K
 ASME Class 150, 300
 (JPI available)

End connection: JIS B2220, ASME B16.5 RF

Face to face: KTM standard

Temperature: Soft seat -29°C to 270°C
 (-20°F to 518°F)
 (Depending on options up to 500°C (932°F) is available)

KTM JACKETED BALL VALVES

FULL BORE AND REDUCED BORE

Open-close position

Open or closed position of the valve is shown by the lever position and shaft top.

- Open: parallel to the piping line
- Close: right-angled in the piping line

A locking device at the open and shut positions to prevent unauthorized or incorrect operation.

Reinforced PTFE bearing

Reinforced PTFE bearing and packing rings provide smooth operation and reduce wear.

ISO 5211 top flange

ISO pad allows precise mounting of actuator, mounting bolts independent from stem packing gland bolts, exact alignment reduces the torque requirement and prevent out-of-line wear.

Gland packing

Multiple layers of adjustable PTFE chevron packing rings, set at lower position of the gland ensure superior sealing of the gland area and prevent media invasion and eventual malfunction of the valve (applicable to standard model).

Blow-out proof shaft

A flange at the lower part of the shaft prevents blow out in case of abnormal pressure rise.

Applicable size:

- Full bore DN 100 (NPS 4) and larger
- Reduced bore DN 150 (NPS 6) and larger

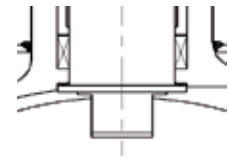

Seat material

Various seat materials are available depending on the application.

- PTFE / PFA copolymer: E-seat (standard)
- PEEK seat (option)
- Gratite® seat (option)
- Metaltite® seat (option)

Jacket

A fully welded jacket in carbon steel.
Max. jacket pressure: 1.0 MPa (145 psi)
Max. jacket temperature: 350°C (662°F)

The fire lip

Designed to eliminate seat deformation and cold flow, the lip acts as a secondary back-up seal, forming a metal to metal contact to in the event the primary soft seat is burned in a fire.

Applicable size:

- Full bore DN 40 (NPS1½) and larger
- Reduced bore DN 80 (NPS 3) and larger

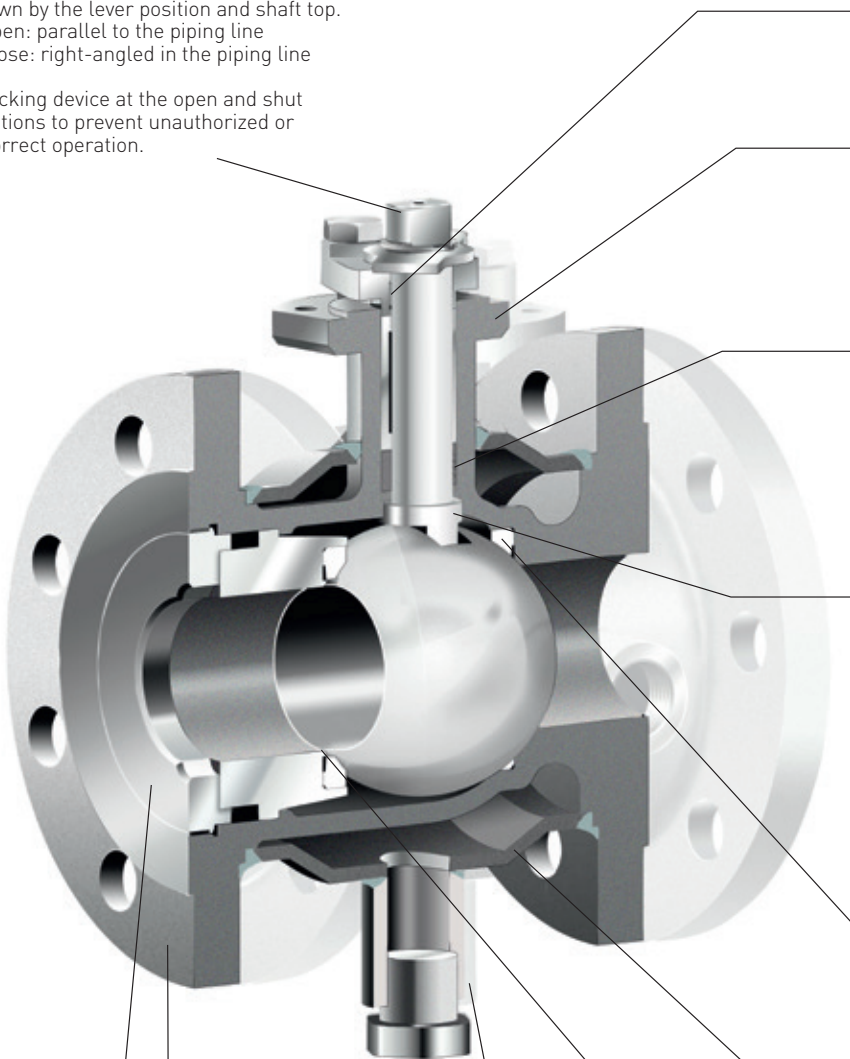

Oversized flange

KTM jacketed valve is designed with oversized flanges, i.e. the flange size exceeds the bore size. The end flange gaskets for piping must be selected accordingly.

Split body cap

To facilitate disassembly and maintenance of the body, the body cap and seat holder are separate items.

Jacket piping

Depending on the valve size two jacket connection are available: $R_p \frac{3}{4}$ and $R_p 1$ [Details as per size table page 5]. Flange type jacket nozzle available on request.

KTM JACKETED BALL VALVES

FULL BORE AND REDUCED BORE

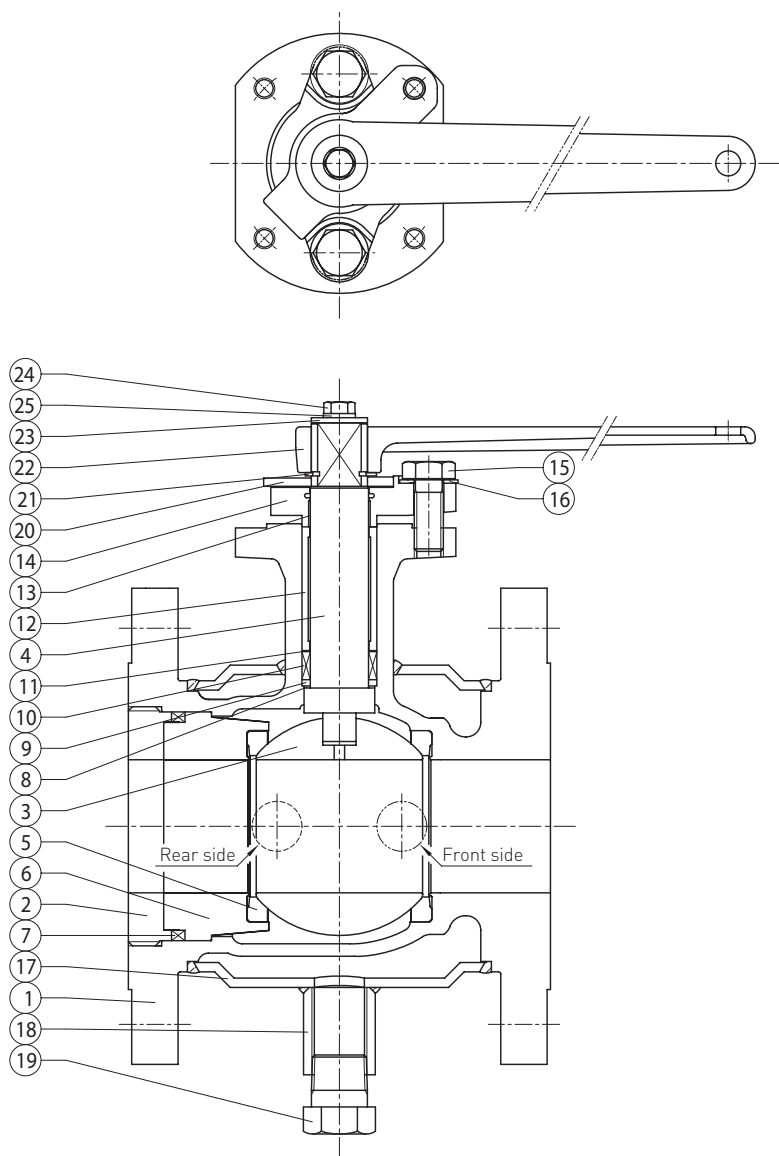

PARTS LIST

No.	Parts name
1	Body
2	Cap
3	Ball
4	Shaft
5	Seat
6	Seat holder
7	Body seal
8	Thrust bearing
9	Thrust washer
10	Gland packing
11	Thrust washer
12	Gland
13	Shaft bearing
14	Gland flange
15	Gland bolt
16	Live loading spring
17	Jacket
18	Socket
19	Plug
20	Stopper
21	Snap ring
22	Handle
23	Washer
24	Bolt
25	Spring washer

PARTS MATERIALS

Body	WCB (SCPH2) CF8 (SCS13A), CF8M (SCS14A)
Ball	CF8 (SCS13A), CF8M (SCS14A)
Shaft	304SS, 316SS
Seat	PTFE / PFA copolymer (E-seat)
Packing	PTFE, R-PTFE
Jacket	Carbon steel

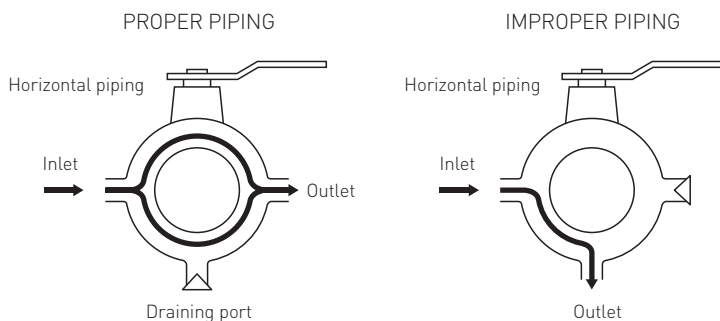

PIPING

When piping the jacketed ball valves, check that no foreign objects will block the inlet, outlet or draining port. Proper piping enables the steam to flow more effectively to warm the jacketed area.

KTM JACKETED BALL VALVES

FULL BORE AND REDUCED BORE - METRIC

PRESSURE-TEMPERATURE RATING

KTM seat ratings: The pressure and temperature limits of KTM E-seat are shown below for valve sizes from DN 15 to DN 250. Seat ratings for high-temperature valves with Gratite® seats are identical to ASME body ratings.

FULL BORE DN 15, DN 20

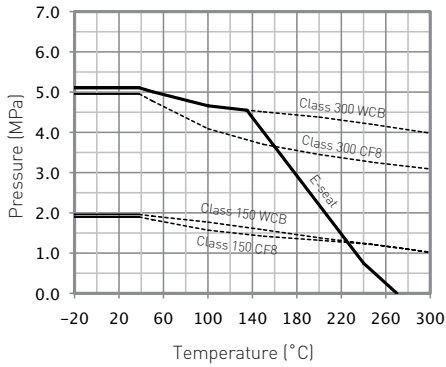

**FULL BORE DN 25 TO DN 65
REDUCED BORE DN 80**

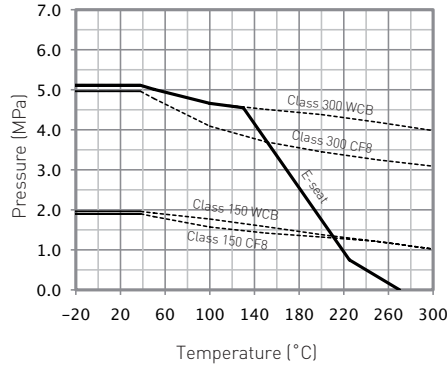

**FULL BORE DN 80 TO DN 100
REDUCED BORE DN 100**

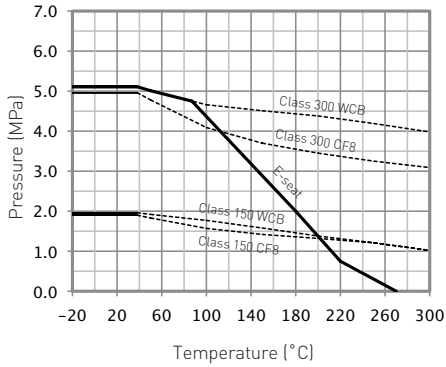

**FULL BORE DN 125, DN 150
REDUCED BORE DN 150 TO DN 200**

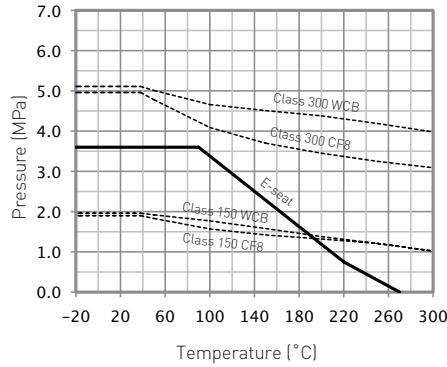

**FULL BORE DN 200
REDUCED BORE DN 250**

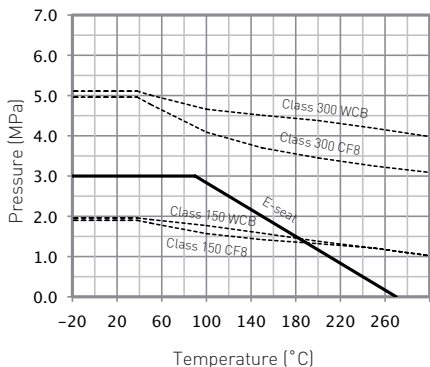

E-SEAT: PTFE / PFA COPOLYMER

Jacket part

Max. pressure: 1.0 MPa
Max. temperature*: 350°C (Carbon steel)

* Jacket must be used under the temperature range of the using seat temperature rating.

KTM JACKETED BALL VALVES

FULL BORE AND REDUCED BORE - IMPERIAL

PRESSURE-TEMPERATURE RATING

KTM seat ratings: The pressure and temperature limits of KTM E-seat are shown below for valve sizes from NPS ½ to NPS 10. Seat ratings for high-temperature valves with Gratiite® seats are identical to ASME body ratings.

FULL BORE NPS ½, ¾

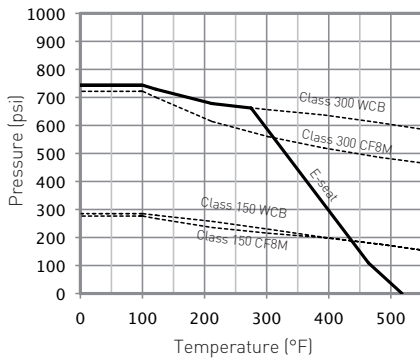

**FULL BORE NPS 1 - 2½
REDUCED BORE NPS 3**

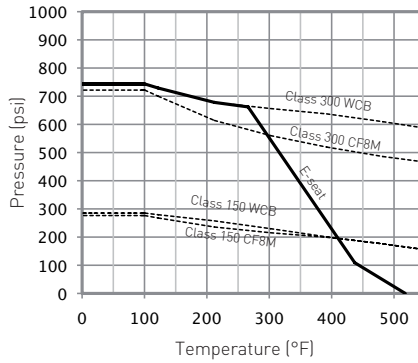

**FULL BORE NPS 3, 4
REDUCED BORE NPS 4, 5**

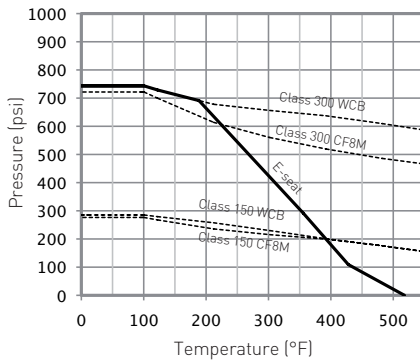

**FULL BORE NPS 5, 6
REDUCED BORE NPS 6, 10**

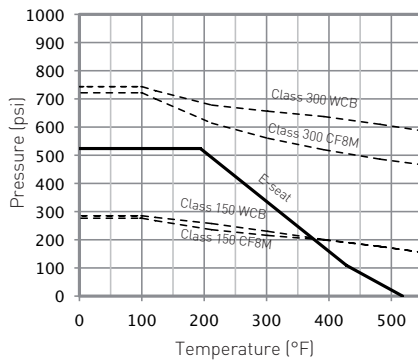

**FULL BORE NPS 8
REDUCED BORE NPS 10**

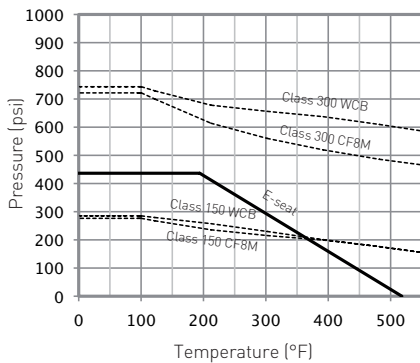

E-SEAT: PTFE / PFA COPOLYMER

Jacket part

Max. pressure: 145 psi
Max. temperature*: 662°F (Carbon steel)

* Jacket must be used under the temperature range of the using seat temperature rating.

KTM JACKETED BALL VALVES

FULL BORE AND REDUCED BORE

FLANGE DIMENSIONS (mm)

Flange size (DN)	JIS 10K							JIS 20K							ASME Class 150							ASME Class 300						
	D	C	G	T	f	N	h	D	C	G	T	f	N	h	D	C	G	T	f	N	h	D	C	G	T	f	N	h
40	140	105	81	16	2	4	19	140	105	81	18	2	4	19	127	98.5	73	14.3	1.6	4	16	156	114.5	73	20.7	1.6	4	22
50	155	120	96	16	2	4	19	155	120	96	18	2	8	19	152	120.5	92	15.9	1.6	4	19	165	127.0	92	22.3	1.6	8	19
65	175	140	116	18	2	4	19	175	140	116	20	2	8	19	178	139.5	105	17.5	1.6	4	19	190	149.0	105	25.4	1.6	8	22
80	185	150	126	18	2	8	19	200	160	132	22	2	8	23	190	152.5	127	19.1	1.6	4	19	210	168.0	127	28.6	1.6	8	22
100	210	175	151	18	2	8	19	225	185	160	24	2	8	23	229	190.5	157	23.9	1.6	8	19	254	200.0	157	31.8	1.6	8	22
150	280	240	212	22	2	8	23	305	260	230	28	2	12	25	279	241.5	216	25.4	1.6	8	22	318	270.0	216	36.6	1.6	12	22
200	330	290	262	22	2	12	23	350	305	275	30	2	12	25	343	298.5	270	28.6	1.6	8	22	381	330.0	270	41.3	1.6	12	25
250	400	355	324	24	2	12	25	430	380	345	34	2	12	27	406	362.0	324	30.2	1.6	12	24	444	387.5	324	47.7	1.6	16	29
350	490	445	413	26	3	16	25	540	480	440	40	3	16	33	533	476.0	413	35.0	1.6	12	29	584	514.5	413	54.0	1.6	20	32

FLANGE DIMENSIONS (inches)

Flange size (NPS)	JIS 10K							JIS 20K							ASME Class 150							ASME Class 300						
	D	C	G	T	f	N	h	D	C	G	T	f	N	h	D	C	G	T	f	N	h	D	C	G	T	f	N	h
1½	5.51	4.13	3.19	0.63	0.08	4	0.75	5.51	4.13	3.19	0.71	0.08	4	0.75	5.00	3.88	2.88	0.56	0.06	4	¾	6.12	4.50	2.88	0.81	0.06	4	¾
2	6.10	4.72	3.78	0.63	0.08	4	0.75	6.10	4.72	3.78	0.71	0.08	8	0.75	6.00	4.75	3.62	0.62	0.06	4	¾	6.50	5.00	3.62	0.87	0.06	8	¾
2½	6.89	5.51	4.57	0.71	0.08	4	0.75	6.89	5.51	4.57	0.79	0.08	8	0.75	7.00	5.50	4.12	0.68	0.06	4	¾	7.50	5.88	4.12	1.00	0.06	8	¾
3	7.28	5.91	4.96	0.71	0.08	8	0.75	7.87	6.30	5.20	0.87	0.08	8	0.91	7.50	6.00	5.00	0.75	0.06	4	¾	8.25	6.62	5.00	1.12	0.06	8	¾
4	8.27	6.89	5.94	0.71	0.08	8	0.75	8.86	7.28	6.30	0.94	0.08	8	0.91	9.00	7.50	6.19	0.94	0.06	8	¾	10.00	7.88	6.19	1.25	0.06	8	¾
6	11.02	9.45	8.35	0.87	0.08	8	0.91	12.01	10.24	9.06	1.10	0.08	12	0.98	11.00	9.50	8.50	1.00	0.06	8	¾	12.50	10.62	8.50	1.44	0.06	12	¾
8	12.99	11.42	10.31	0.87	0.08	12	0.91	13.78	12.01	10.83	1.18	0.08	12	0.98	13.50	11.75	10.62	1.12	0.06	8	¾	15.00	13.00	10.62	1.62	0.06	12	1
10	15.75	13.98	12.76	0.94	0.08	12	0.98	16.93	14.96	13.58	1.34	0.08	12	1.06	16.00	14.25	12.75	1.18	0.06	12	1	17.50	15.25	12.75	1.87	0.06	16	1½
14	19.29	17.52	16.26	1.02	0.12	16	0.98	21.26	18.90	17.32	1.57	0.12	16	1.30	21.00	18.75	16.25	1.37	0.06	12	1½	23.00	20.25	16.25	2.12	0.06	20	1¼

C_v VALUES

Valve size DN (NPS)	Full bore	Reduced bore
20 (¾)	50	-
25 (1)	94	-
40 (1½)	260	-
50 (2)	480	-
80 (3)	1300	420
100 (4)	2300	770
150 (6)	5400	1800
200 (8)	10000	2500
250 (10)	-	4500

KTM JACKETED BALL VALVES

FULL BORE AND REDUCED BORE

NEW KTM MODEL CODING SYSTEM

Example:		JB11	-	-	31	1E	J10	RF	25	
Valve code	Class	Description								
	ASME JIS									
JB11	150 10K	Full bore, Floating type DN 15 - 200								
JB12	300 20K	Full bore, Floating type DN 15 - 200								
JB21	150 10K	Reduced bore, Floating type DN 80 - 250								
JB22	300 20K	Reduced bore, Floating type DN 80 - 250								
Sub code	Description									
Blank	Soft seat									
M	Metaltite® seat									
G	Gratite® seat									
Special feature	Description									
Blank	Not applicable									
Body code	Material									
	JIS	ASTM								
31	SCS13A (304)	CF8 (304)								
32	SCS14A (316)	CF8M (316)								
62	SCPH2	WCB								
Trim code										
See trim code table										
Flange code	Description		Flange code	Description						
	ASME			JIS						
A15	ASME Class 150		J10	JIS 10K						
A30	ASME Class 300		J20	JIS 20K						
[JPI also available]										
Connection code	Description									
RF	Raised face (125 to 250 AARH)									
FF	Flat face									
Size code	15	20	25	40	50	65	125	150	200	250
DN	15	20	25	40	50	65	125	150	200	250
NPS	1/2	3/4	1	1 1/2	2	2 1/2	5	6	8	10
Option code	Description									
Blank	No additional option									
GG	Packing / Gasket-graphite									
JI	Flange type jacket nozzle									

TRIM CODE

Code	Ball		Seat	Packing	Shaft
	JIS	ASTM			
Soft seat					
1E	SCS13A ^[1] or SCS14A ^[2]	CF8 ^[1] or CF8M ^[2]	PTFE / PFA Copolymer	PTFE or R-PTFE	304 ^[1] or 316 ^[2]
1G	SCS13A ^[1] or SCS14A ^[2]	CF8 ^[1] or CF8M ^[2]	R-PTFE	PTFE or R-PTFE	304 ^[1] or 316 ^[2]
5E ^[1]	SCS14A	CF8M	PTFE / PFA Polymer	PTFE or R-PTFE	304 ^[1] or 316 ^[2]
5G	SCS14A	CF8M	R-PTFE		304 ^[1] or 316 ^[2]
PEEK seat					
KR	SCS13A ^[1] or SCS14A ^[2]	CF8 ^[1] or CF8M ^[2]	PEEK	R-PTFE	329J1 SS
KC	SCS13A ^[1] or SCS14A ^[2]	CF8 ^[1] or CF8M ^[2]	PEEK	Graphite	329J1 SS
Metaltite® seat					
AY	SCS13A / HCr ^[1] or SCS14A / HCr ^[2]	CF8 / HCr ^[1] or CF8M / HCr ^[2]	316 Stellite	R-PTFE	329J1 SS
BY	SCS13A / SFNi ^[1] or SCS14A / SFNi ^[2]	CF8 / SFNi ^[1] or CF8M / SFNi ^[2]	316 Stellite	R-PTFE	329J1 SS
AG	SCS13A / HCr ^[1] or SCS14A / HCr ^[2]	CF8 / HCr ^[1] or CF8M / HCr ^[2]	316 Stellite	Graphite	329J1 SS
BG	SCS13A / SFNi ^[1] or SCS14A / SFNi ^[2]	CF8 / SFNi ^[1] or CF8M / SFNi ^[2]	316 Stellite	Graphite	329J1 SS
BX	SCS13A / SFNi ^[1] or SCS14A / SFNi ^[2]	CF8 / SFNi ^[1] or CF8M / SFNi ^[2]	316 Stellite	Graphite	Hastelloy-C
Gratite® seat					
CC	SCS13A ^[1] or SCS14A ^[2]	CF8 ^[1] or CF8M ^[2]	Hard graphite	Graphite	329J1 SS

1. Body code 31 and 62

2. For body code 32 only

HCr: Hard chromium plating

SFNi: Nickel alloy overlay