

Series 26s Ball Valve with floating or trunnion-mounted ball

Application:

High-performance ball valve with long-term reliable shut-off performance suitable for various fields of applications in industrial processes:

- Nominal size: DN 25 to 800 or NPS 1 to NPS 32
- Nominal pressure: PN 10 to 40 or Class 150 and 300 as well as graduated in high pressure range
- Temperature: -196 to +550 °C depending on version and materials used

The ball valves can be used in the chemical and petrochemical industries, power and utilities, gas transportation and storage as well as other plants.

The adaptation of the valve construction allows it to be used with media containing solids as well as in cryogenic or high-temperature applications.

The Series 26s Ball Valve has the following properties, depending on the version:

- **Body version**
 - Two-pieced flanged body (up to DN 500/NPS 20)
- **Seat version**
 - Soft-seated, not spring-loaded
 - Soft-seated, spring-loaded
 - Soft-seated, with metal chambering and spring-loaded
 - Metal-seated, spring-loaded on both sides
- **Body material**
 - Steel
 - Stainless steel
 - High-alloy steels and special materials
- **Other features**
 - High-grade materials used for seals
 - Better casting quality
 - Bearings suitable for higher loads
 - Anti-static design
 - Blowout-proof shaft
 - Maintenance-free, spring-loaded packing meets requirements stipulated by TA Luft (2002)
 - Fire-safe according to API 607 4th edition
 - Face-to-face dimensions according to EN 558 or ASME B16.10/API 6D
 - Flange according to EN 1092 or ASME B16.5/API 6D
 - Actuator design according to ISO 5211



Fig. 1 - Series 26s Ball Valve with Series 31a AT Rotary Actuator, SRP 5000



Fig. 2 - Series 26s Ball Valve in high-pressure version



Fig. 3 - Series 26s Ball Valve with Bettis pneumatic actuator

Fields of application:

- Alkaline solutions
- Acids
- Gases
- Steam
- Hydrocarbons
- Medium containing solids
- Vacuum

Versions:

- Manually operated ball valve with lever
- Manually operated ball valve with gear
- Ball valve with pneumatic actuator
- Ball valve with electric actuator
- Ball valve with hydraulic actuator
- Suitable for fast-closing actuators

Special versions:

- Body heating
- Various types of flanges and end connections
- Modified seat rings with chambering, other materials
- Non-stick coating inside body
- Rinsing ports and rinsing nozzles
- Version for media containing solids
- Low-temperature version
- High-temperature version
- High-pressure version
- Special materials

Additional equipment and mounting parts:

The following accessories are available (separately or in combination):

- Backup packing
- Shaft extension
- Locking devices
- Equipment for partial stroke testing
- Limit switch
- Solenoid valves
- Air pressure reducing station with filter
- Pressure gauge mounting blocks
- Positioner

Further accessories are available on request to meet customer specifications.



Fig. 4 - Series 26s Ball Valve with Type 31a Rotary Actuator



Fig. 5 - Series 26s Ball Valve with Type 31a Rotary Actuator



Fig. 6 - Series 26s Ball Valve version for the petrochemical industry

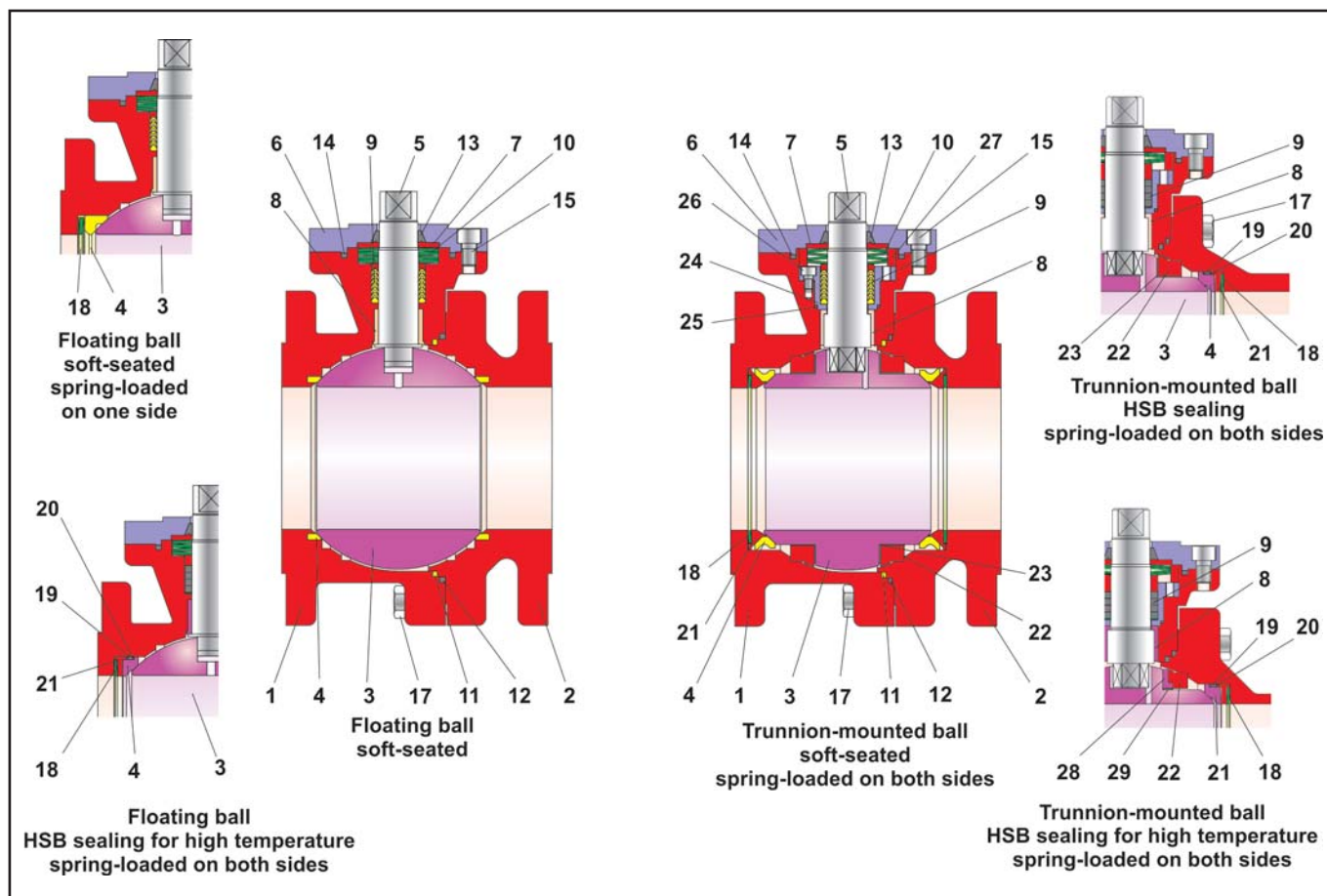

Fig. 7 - Sectional drawings of the ball valve versions

Pos.	Designation
1	Main body
2	Side body
3	Ball
4	Seat ring
5	Shaft
6	Packing flange
7	Bushing
8	Bearing bushing
9	Packing
10	Set of Belleville washers
11	Seal
12	Seal
13	Fire-safe gasket
14	Ring
15	Fillister head screw

Table 1 - Parts list

Pos.	Designation
16	Screw plug*
17	Hex screw
18	Disk spring
19	Ring
20	Thrust ring
21	Thrust ring
22	Bearing shell
23	Compound bearing
24	Packing bearing
25	Seal
26	Fillister head screw
27	Centering ring
28	Bearing bushing
29	Perforated sheet reinforcement

* The screw plug is not visible in the above drawings

Advantages of the live-loaded sealing system:

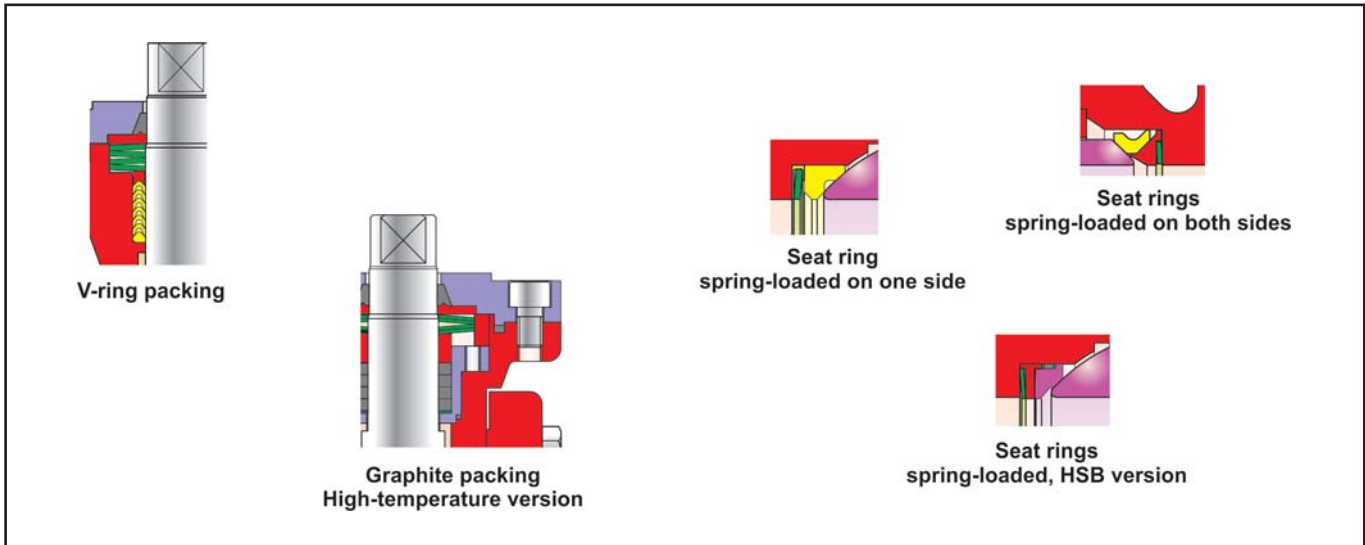

Fig. 8 - Spring-loaded packings and seat rings

- Maintenance-free and self-adjusting
- Two active seat rings
- Highest level of sealing, even under extreme pressure and temperature fluctuations
- Longer service life
- Smaller rise in torque due to an increase in temperature. As a result, smaller actuators can be used.
- **All in all: extremely economic!**

Seat rings:

All seat rings used in Pfeiffer ball valves are designed for low torques and provide excellent shut-off performance. They allow the valves to be opened and closed in all operating conditions.

In floating ball valves, seat rings that are not spring-loaded are usually used on both sides. Alternatively, a seat ring spring-loaded on one side can be selected to match severe operating conditions.

Trunnion-mounted ball valves have active seat rings which have metal chamfering. All sealing systems are optimized by applying FEM calculations and have been proven in practice. As a result, excellent shut-off performance is achieved in conventional applications as well as during extreme operating conditions and even in the event of a fire in the plant.

When abrasive media or media at high temperatures are used, the floating or trunnion-mounted ball valves can be used with metal-to-metal sealing systems with hard coatings. These valves have a very hard surface and excellent wear resistance. Additionally, their torque characteristic is hardly

affected by varying environmental conditions, such as fluctuations in temperature or pressure.

A suitable metal-to-metal sealing system is available for all medium with increased requirements. Besides the high grade standard coatings, versions are also available with highly resistant materials and suitable for reduced torque or very frequent switching in on/off service. Please contact Pfeiffer if you are planning to use these sealing systems.

All sealing systems (except for the special versions) are designed to meet fire-safe requirements available in all nominal sizes. To meet special requirements, a wide range of solutions are available, e.g. solutions with encapsulated springs, low-temperature sealing faces as well as versions suitable for media containing solids.



Fail-safe position:

Depending on how the pneumatic actuator is mounted to the valve, the ball valve has two fail-safe positions which become effective when the air pressure in the actuator is relieved or when the supply air fails.

Ball valve with fail-close actuator (FC):

Upon failure of the air supply, the ball valve closes. The ball valve opens against the force of the springs when the air pressure rises.

Ball valve with fail-open actuator (FO):

Upon failure of the air supply, the ball valve opens. The ball valve closes against the force of the springs when the air pressure rises.

General technical data

Nominal size	DN 25 to 800 or NPS 1 to NPS 32
Nominal pressure	PN 10 to 40 or Class 150 and 300 as well as up to max. PN 400 or Class 2500
Bauform	Flanges according to EN 1092 and ANSI B16.5/API 6D Two-pieced body up to DN 500/NPS 20 Three-pieced body DN 600 and higher/NPS 24 and higher
Temperature range	According to pressure-temperature diagram
Seat leakage	Soft-seated: Test P12 – EN 12266-1, leakage rate A Class VI – ANSI/FCI 70-2-1991 Metal-to-metal: Test P12 – EN 12266-1, leakage rate B (optional A) Class V – ANSI/FCI 70-2-1991 (optional Class VI)
Face-to-face dimensions	EN 558 R1 or R27/R15 ASME B16.10 or API 6D – regular pattern High pressure in PN 63 and higher/Class 600 and higher: EN 558 R2 or ASME B16.10 or API 6D – regular pattern
Flange type	EN 1092-1 Form B1 up to PN 40 EN 1092-1 Form B2 for PN 63 and higher ASME B16.5 RF smooth finish
Permissible operating pressures	According to pressure-temperature diagram

Table 2 - Technical data

Materials:

Body	1.0619 – A216 WCB/WCC 1.6220 – A352 LCB/LCC 1.4408 – A351 CF8M Optional special materials for body
Ball	1.4408 – A351 CF8M · Optional HSB3 metal-to-metal sealing system
Shaft	1.4462 – A182 F51 · Optional 1.4980 – AISI 660
Seat rings	TFM (PTFE), PTFE compounds, Devlon V®, special plastics Optional HSB3 metal-to-metal sealing system
Spring for seat ring	1.4310 / 1.4401 / 2.4668
Packing	PTFE V-rings Optional Inconel wire reinforced graphite/fiber yarn packing
Bearing bushing	PTFE/glass Optional stainless steel reinforced by PTFE/glass/carbon/graphite compound Optional stainless steel bushings with hard coating
Body gasket	PTFE/graphite · Optional graphite/graphite
Surface treatment	Standard treatment: C steel with manganese phosphate coating

Table 3 - Materials

Maximum torques for shafts and ball valve version

Nominal size	1.4571 A182 F316Ti	1.4462 A182 F51	1.4980 AISI660	PN 10	PN 25 Class 150	PN 25	PN 40 Class 300
DN 25/NPS 1	158	338	451	Floating ball			
DN 40/NPS 1½	305	654	872				
DN 50/NPS 2	305	654	872				
DN 80/NPS 3	466	998	1331	Floating or trunnion-mounted ball			
DN 100/NPS 4	466	998	1331				
DN 125/NPS 5	1074	2302	3069				
DN 150/NPS 6	1961	4202	5602				
DN 200/NPS 8	3222	6905	9207				
DN 250/NPS 10	3340	7156	9542				
DN 300/NPS 12	7059	15126	20168	Trunnion-mounted ball			
DN 350/NPS 14	7059	15126	20168				
DN 400/NPS 16	15121	32403	43204				
DN 450/NPS 18	15121	32403	43204				
DN 500/NPS 20	28293	60628	80837				
DN 600/NPS 24	57463	123133	164177				
DN 700/NPS 28	57463	123133	164177				
DN 800/NPS 32	99035	212218	282957				

Table 4 - Torques in Nm

Torques:• **Sealing system for floating ball: TFM seat ring**

Differential pressure Δp in bar		0	5	10	15	16	20	25	30	40	50
Nominal size	ISO	Breakaway torque Mdl in Nm									
DN 25/NPS 1	F05 / SW14	10	12	14	17	18	20	22	24	28	32
DN 40/NPS 1½	F07 / SW17	20	23	26	34	35	38	41	44	52	59
DN 50/NPS 2	F07 / SW17	30	33	36	41	42	47	53	60	73	86
DN 80/NPS 3	F10 / SW19	60	66	72	84	86	96	108	120	144	-
DN 100/NPS 4	F10 / SW19	90	105	120	137	140	159	182	205	251	-
DN 125/NPS 5	F12 / SW24	170	232	294	356	368	418	480	-	-	-
DN 150/NPS 6	F14 / SW30	240	305	370	425	436	480	-	-	-	-
DN 200/NPS 8	F16 / SW36	330	390	450	-	-	-	-	-	-	-

Table 5 - Torques

• **Sealing system for floating ball: PTFE/carbon seat ring**

Differential pressure Δp in bar		0	5	10	15	16	20	25	30	40	50
Nominal size	ISO	Breakaway torque Mdl in Nm									
DN 25/NPS 1	F05/SW14	13	16	18	22	23	26	29	31	36	42
DN 40/NPS 1½	F07/SW17	26	30	34	44	46	49	53	57	68	77
DN 50/NPS 2	F07/SW17	39	43	47	53	55	61	69	78	95	112
DN 80/NPS 3	F10/SW19	78	86	94	109	112	125	140	156	187	218
DN 100/NPS 4	F10/SW19	117	137	156	206	182	207	237	267	326	-
DN 125/NPS 5	F12/SW24	221	302	382	463	478	543	624	705	-	-
DN 150/NPS 6	F14/SW30	312	396	481	553	567	624	695	766	-	-
DN 200/NPS 8	F16/SW36	429	507	585	663	679	741	-	-	-	-

Table 6 - Torques

• **Metal-to-metal sealing system for floating ball: HSB3 in high-temperature version**

Differential pressure Δp in bar		0	5	10	15	16	20	25	30	40	50
Nominal size	ISO	Breakaway torque Mdl in Nm									
DN 25/NPS 1	F05/SW14	25	37	48	59	61	70	82	93	115	138
DN 40/NPS 1½	F07/SW17	31	44	56	69	71	81	94	106	131	156
DN 50/NPS 2	F07/SW17	50	70	90	110	114	130	150	170	210	250
DN 80/NPS 3	F10/SW19	119	179	238	297	309	356	-	-	-	-
DN 100/NPS 4	F10/SW19	200	294	388	482	500	-	-	-	-	-

Table 7 - Torques

• **Sealing system for trunnion-mounted ball: TFM seat ring with metal chambering**

Differential pressure Δp in bar		0	5	10	15	16	20	25	30	40	50
Nominal size	ISO	Breakaway torque Mdl in Nm									
DN 80/NPS 3	F10/SW19	50	59	69	79	81	88	98	108	127	146
DN 100/NPS 4	F10/SW19	50	68	87	106	110	125	144	163	201	239
DN 125/NPS 5	F12/SW24	115	155	194	233	241	273	312	352	430	509
DN 150/NPS 6	F14/SW30	126	180	233	286	297	340	393	446	553	660
DN 200/NPS 8	F16/SW36	209	318	427	536	558	645	754	863	1081	1299
DN 250/NPS 10	F16/SW36	321	487	653	819	852	985	1151	1316	1648	1980
DN 300/NPS 12	F25/VK50	500	744	989	1233	1282	1478	1722	1967	2455	2944
DN 350/NPS 14	F25/VK50	665	1080	1495	1910	1993	2326	2741	3156	3986	-
DN 400/NPS 16	F30/VK65	974	1476	1977	2479	2579	2980	3481	3983	4986	-
DN 450/NPS 18	F30/VK65	996	1735	2472	3212	3360	3951	4689	5428	6905	-
DN 500/NPS 20	F35/VK80	1857	3302	4747	6193	6482	7638	9083	10528	-	-
DN 600/NPS 24	F40/VK100	2593	4770	6948	9126	9562	11304	13482	15660	-	-
DN 700/NPS 28	F40/VK100	2641	6023	9405	12788	13464	16170	19552	-	-	-
DN 800/NPS 32	F48/VK120	4577	10501	16426	22350	23535	51500	34199	-	-	-

Table 8 - Torques

• **Sealing system for trunnion-mounted ball: PTFE/carbon seat ring with metal chambering**

Differential pressure Δp in bar		0	5	10	15	16	20	25	30	40	50
DN	ISO	Breakaway torque Mdl in Nm									
DN 80/NPS 3	F10/SW19	77	88	100	111	113	123	134	146	168	191
DN 100/NPS 4	F10/SW19	76	98	121	143	148	166	188	211	256	300
DN 125/NPS 5	F12/SW24	165	214	263	311	321	360	409	457	554	652
DN 150/NPS 6	F14/SW30	151	214	277	339	352	402	465	528	654	780
DN 200/NPS 8	F16/SW36	276	400	523	647	671	770	893	1017	1264	1510
DN 250/NPS 10	F16/SW36	466	660	855	1049	1088	1244	1439	1633	2022	2411
DN 300/NPS 12	F25/VK50	639	919	1200	1480	1536	1761	2041	2322	2883	3444
DN 350/NPS 14	F25/VK50	918	1392	1866	2341	2436	2816	3289	3764	4712	5661
DN 400/NPS 16	F30/VK65	1294	1861	2427	2993	3107	3560	4126	4693	5825	6958
DN 450/NPS 18	F30/VK65	1297	2129	2960	3791	3958	4623	5454	6285	7948	9610
DN 500/NPS 20	F35/VK80	2365	4046	5727	7407	7743	9088	10769	12449	15810	19172
DN 600/NPS 24	F40/VK100	3291	5791	8292	10793	11293	13293	15794	18295	23296	28297
DN 700/NPS 28	F40/VK100	3372	7232	11091	14951	15722	18810	22669	26529	34248	41967
DN 800/NPS 32	F48/VK120	6427	13175	19922	26670	28019	33417	40164	46912	60407	73902

Table 9 - Torques

• **Metal-to-metal sealing system for trunnion-mounted ball: HSB3**

Differential pressure Δp in bar		0	5	10	15	16	20	25	30	40	50
Nominal size	ISO	Breakaway torques Mdl in Nm									
DN 80/NPS 3	F10/SW19	62	79	96	113	116	130	147	164	198	233
DN 100/NPS 4	F10/SW19	67	104	142	179	187	217	255	292	367	442
DN 125/NPS 5	F12/SW24	170	220	269	319	329	368	418	467	566	665
DN 150/NPS 6	F14/SW30	194	272	351	429	445	507	585	663	819	975
DN 200/NPS 8	F16/SW36	274	453	633	812	848	991	1170	1349	1708	2066
DN 250/NPS 10	F16/SW36	372	657	942	1227	1284	1512	1797	2082	2651	3221
DN 300/NPS 12	F25/VK50	573	992	1410	1828	1912	2247	2665	3083	3920	4756
DN 350/NPS 14	F25/VK50	735	1435	2136	2836	2976	3536	4236	4937	6337	7738
DN 400/NPS 16	F30/VK65	1232	2068	2903	3739	3906	4574	5409	6245	7916	9586
DN 450/NPS 18	F30/VK65	1335	2520	3705	4890	5127	6075	7260	8445	10815	13185
DN 500/NPS 20	F35/VK80	2306	4885	7464	10043	10558	12621	15200	17779	22936	-
DN 600/NPS 24	F40/VK100	3321	7063	10804	14546	15294	18287	22029	25771	33254	-
DN 700/NPS 28	F40/VK100	3644	9324	15003	20683	21819	26362	32042	37722	49081	-
DN 800/NPS 32	F48/VK120	4898	14785	24672	34559	36537	44446	54334	64221	83995	-

Table 10 - Torques

• **Metal-to-metal sealing system for trunnion-mounted ball: HSB3 in high-temperature version**

Differential pressure Δp in bar		0	5	10	15	16	20	25	30	40	50
Nominal size	ISO	Breakaway torques Mdl in Nm									
DN 80/NPS 3	F10/SW19	62	83	105	126	130	147	169	190	233	276
DN 100/NPS 4	F10/SW19	67	113	159	205	215	252	298	344	437	529
DN 125/NPS 5	F12/SW24	170	230	290	350	362	409	469	529	649	768
DN 150/NPS 6	F14/SW30	194	298	402	505	526	609	713	817	1024	1231
DN 200/NPS 8	F16/SW36	274	527	779	1032	1083	1285	1537	1790	2295	2800
DN 250/NPS 10	F16/SW36	372	742	1112	1481	1555	1851	2221	2590	3330	4069
DN 300/NPS 12	F25/VK50	574	1141	1708	2275	2398	2842	3410	3977	5111	6245
DN 350/NPS 14	F25/VK50	735	1697	2658	3620	3812	4581	5543	6504	8427	10350
DN 400/NPS 16	F30/VK65	1232	2410	3587	4765	5000	5942	7120	8297	10653	13008
DN 450/NPS 18	F30/VK65	1335	3036	4736	6437	6777	8137	9837	11538	14939	18339
DN 500/NPS 20	F35/VK80	2306	5678	9049	12420	13095	15792	19163	22534	29277	36020
DN 600/NPS 24	F40/VK100	3321	8385	13449	18512	19525	23576	28640	33703	43831	53958
DN 700/NPS 28	F40/VK100	3644	11474	19304	27134	28700	34964	42793	50623	66283	81943
DN 800/NPS 32	F48/VK120	4898	18602	32306	46010	48751	59715	73419	87123	114531	141940

Table 11 - Torques

The above listed torques are based on an opening ball valve at the specified differential pressure. The measurements were made using water containing corrosion inhibitor at room temperature and waiting one day before opening the valve.

Factors, such as temperature, pressure, medium, on/off switching frequency and idles times, are taken into account on selecting and sizing the actuator. Contact Pfeiffer in case of doubt.

Pressure-temperature diagrams:

The pressure-temperature ratings of the pressure-bearing body parts meet the requirements stipulated in DIN EN 12516-1 and ASME B16.34. Contact Pfeiffer to find out the individual pressure limits when the pressure specifications are above the specifications given in the standards. The pressure-temperature diagrams are based on the specified sealing system and always depend on the ball valve version.

- **PTFE sealing system (floating ball)**

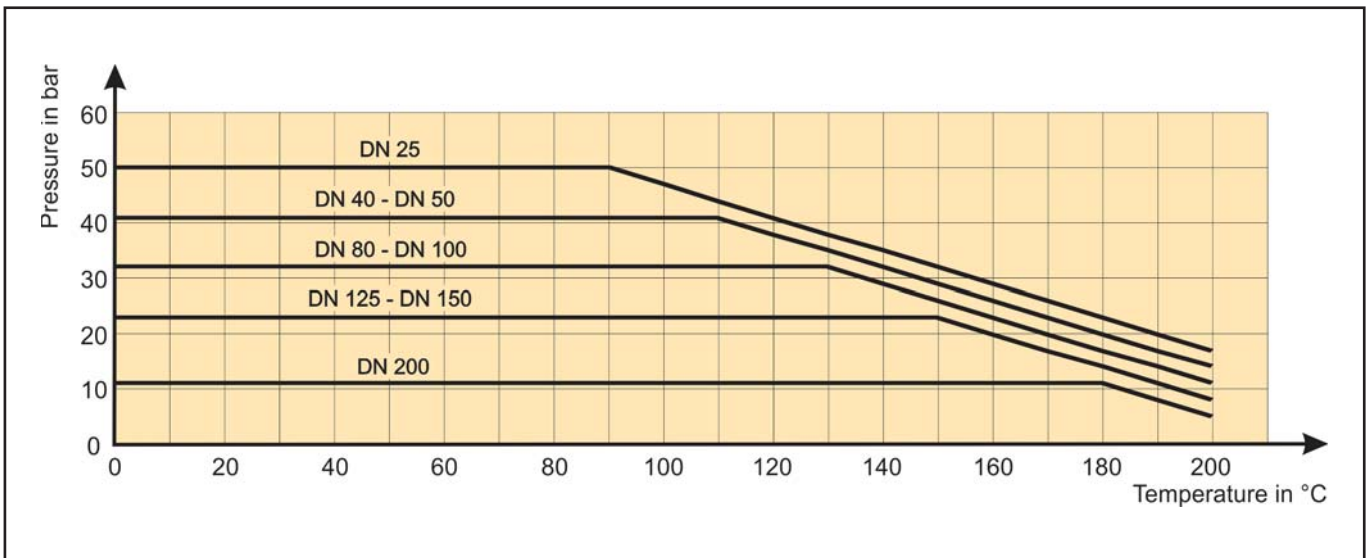

Fig. 9 - Pressure-temperature diagram

- **PTFE/carbon sealing system (floating ball)**

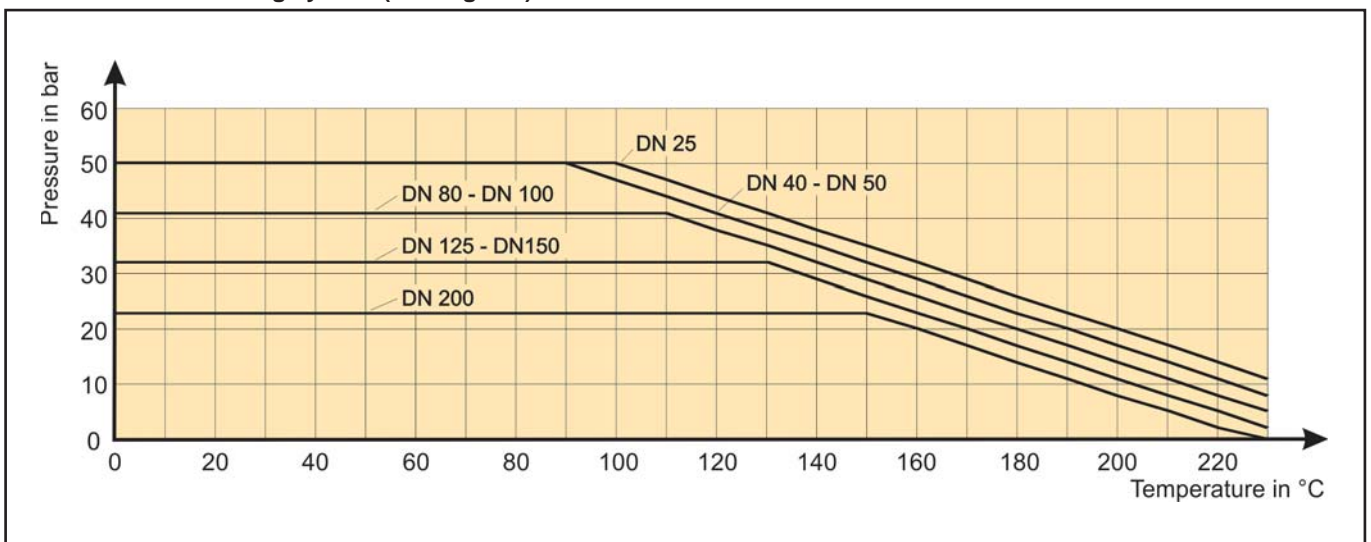

Fig. 10 - Pressure-temperature diagram

• PTFE sealing system (trunnion-mounted ball)

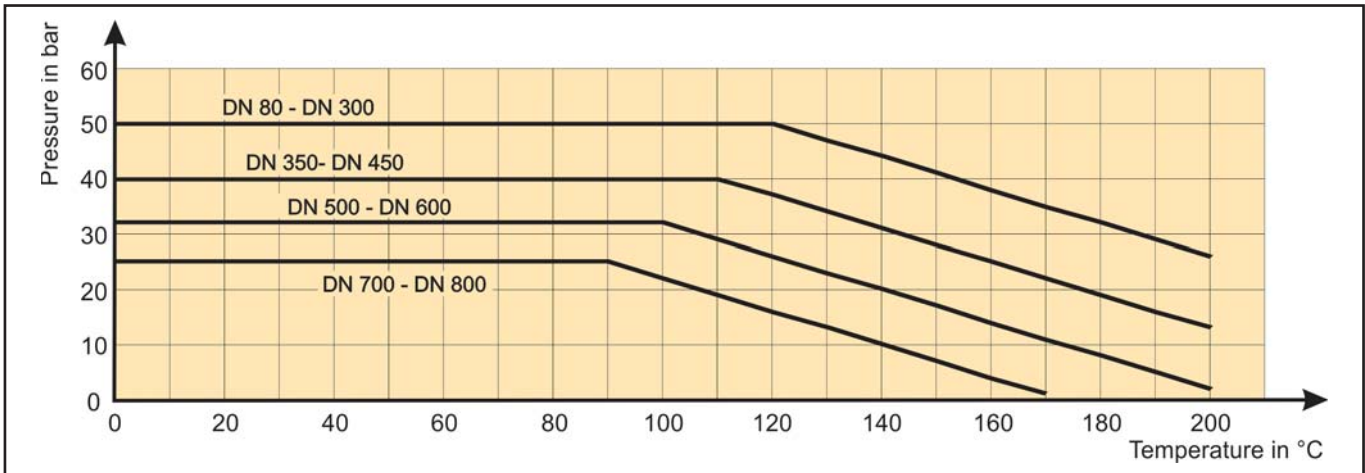

Fig. 11 - Pressure-temperature diagram

• PTFE/carbon sealing system (trunnion-mounted ball)

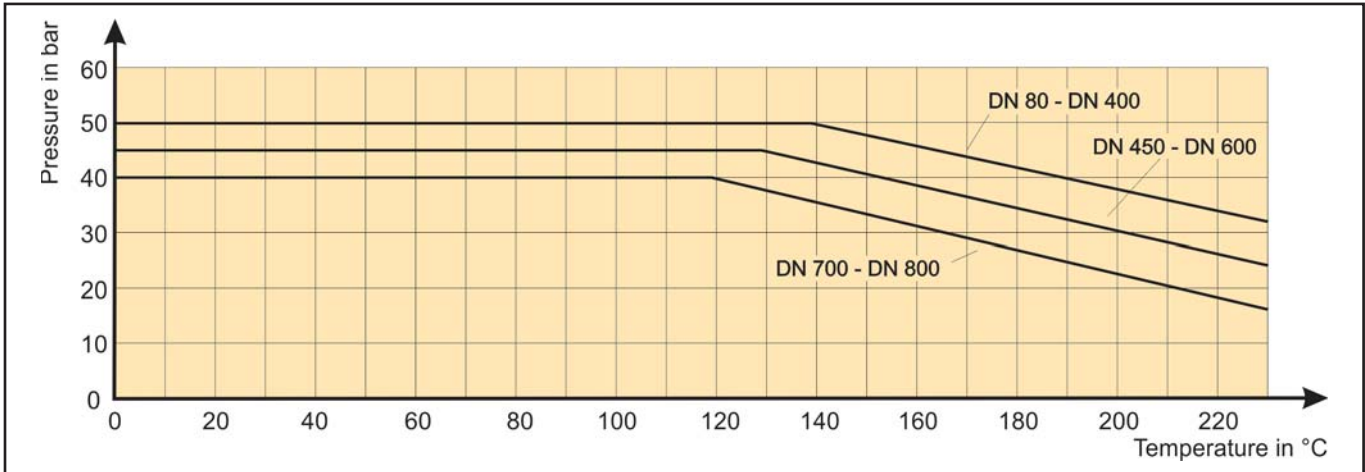

Fig. 12 - Pressure-temperature diagram

• HSB3 sealing system (floating and trunnion-mounted balls)

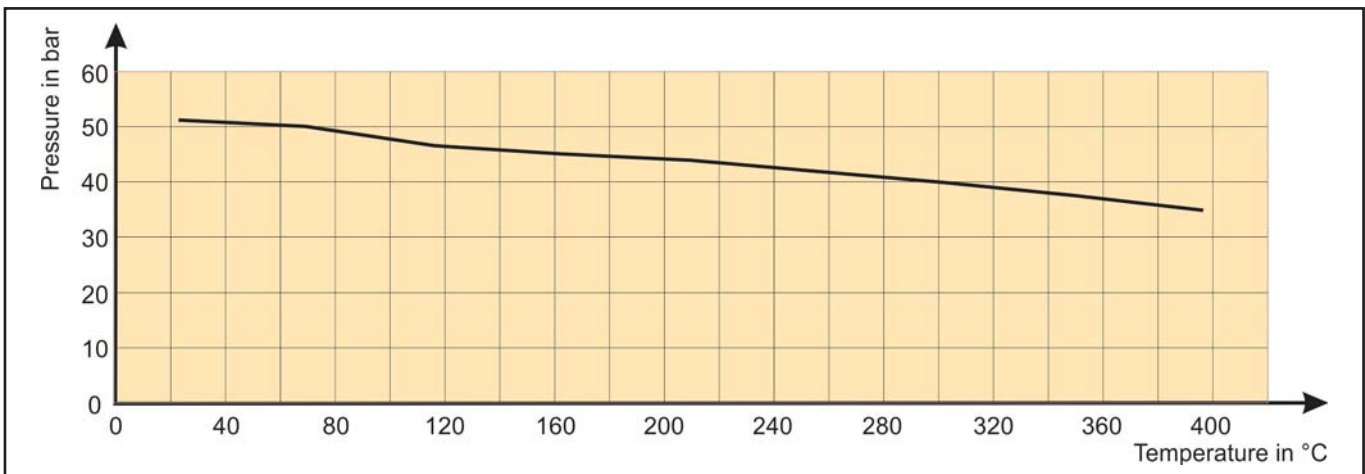

Fig. 13 - Pressure-temperature diagram

Please contact Pfeiffer for more details on the pressure and temperature limits for sealing systems made of other plastics or for sealing systems suitable for specific operating conditions.



Dimensions and weights:

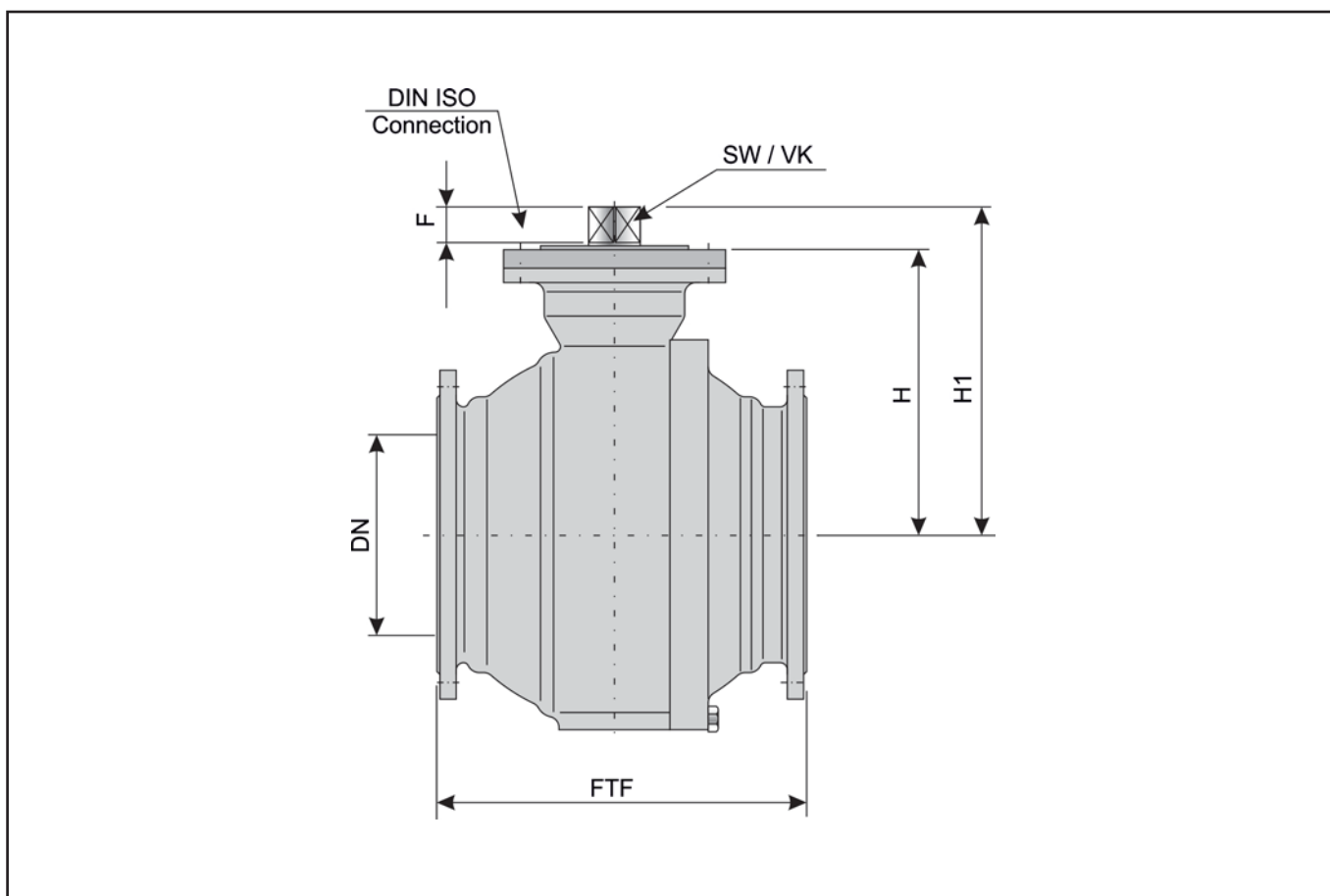

Fig. 14 - Dimensional drawing

Nominal size	FTF R1	FTF R27/15	FTF CI 150	FTF CI 300	H	H1	F	SW/VK	DIN ISO	Weight 1	Weight R27/15	Weight CI 150	Weight CI 300
DN 25/NPS 1	160	125	127	165	58	77	14	SW14	F05	4.7	4.4	4.5	4.7
DN 40/NPS 1½	200	140	165	191	85	107	17	SW17	F07	9.5	8.9	9.2	9.6
DN 50/NPS 2	230	150	178	216	93	115	17	SW17	F07	12.0	11.4	11.0	12.5
DN 80/NPS 3	310	180	203	283	147	173	19	SW19	F10	24	27	28	32
DN 100/NPS 4	350	190	229	305	162	188	19	SW19	F10	40	38	38	49
DN 125/NPS 5	400	325	356	381	225	256	24	SW24	F10	75	70	78	82
DN 150/NPS 6	480	350	394	403	231	268	30	SW30	F14	102	97	93	110
DN 200/NPS 8	600	400	457	502	269	313	36	SW36	F16	202	147	172	212
DN 250/NPS 10	-	450	533	568	320	364	36	SW36	F16	-	276	291	348
DN 300/NPS 12	-	500	610	648	386	444	50	VK50	F25	-	470	443	501
DN 350/NPS 14	-	550	686	762	485	543	50	VK50	F25	-	625	586	814
DN 400/NPS 16	-	762	762	838	490	577	65	VK65	F30	-	734	662	947
DN 450/NPS 18	-	864	864	914	596	656	65	VK65	F30	-	1141	1067	1370
DN 500/NPS 20	-	914	914	991	605	696	80	VK80	F35	-	2464	2400	2820
DN 600/NPS 24	-	1067	1067	1143	679	789	100	VK100	F40	-	3462	3420	3970
DN 700/NPS 28	-	1245	1245	1346	749	859	100	VK100	F40	-	5018	4960	5720
DN 800/NPS 32	-	1372	1372	1524	863	995	120	VK120	F48	-	7222	7110	7840

Table 12 - Dimensions in mm and weights in kg

Selection and sizing of the ball valve:

1. Determine the required nominal size.
2. Select the valve taking into account the required materials and other equipment within the pressure-temperature limits.
3. Select the appropriate actuator with the required torque at the differential pressure and include sufficient safety reserve.
4. Select additional equipment for actuator control and feedback.



Note: All details relevant for the ordered version which deviate from those in the technical specifications can be taken from the corresponding order confirmation, if required.

Ordering text:

- Series 26s Ball Valve
- Temperature:
- Pressure:
- Medium:
- Planned on/off switching frequency:
- Optional: Ball bearing
- DIN or ANSI version
- DN/NPS and PN/Class
- End connections:
- Body material
- Packing material
- Optional special equipment
- Actuator (brand name):
- Mounting location of actuator
- Signal pressure bar
- Fail-safe action
- Limit switch (brand name):
- Solenoid valve (brand name):
- Optional position transmitter (brand name):
- Others